

Das bin ich!
(Foto oder Zeichnung)



Dieses Buch gehört:



Meine Familie:

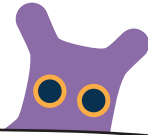

Large empty box for drawing or writing.

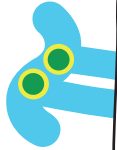

Das finde ich gut!
(kreise ein!)



Reisen

Mathe

Lesen

Fußball

Basteln

Zeichnen

Sommer

Abenteuer

Winter

Eis

Kino

Schwimmen

Musik

Einkaufen

Regenwetter

Gemüse

Hitze

Dunkelheit

Früh aufstehen

Aufräumen

Still sitzen

Langeweile



Mathe

Spazieren

Das finde ich doof!



Dorthin würde ich gerne einmal reisen:

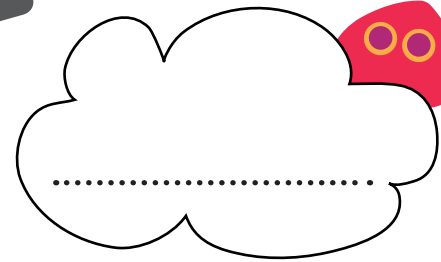

Damit bringe
ich meine
Eltern auf die Palme:



Large empty box for drawing or writing.

Wenn ich eine Süßigkeit
wäre, wäre ich ...

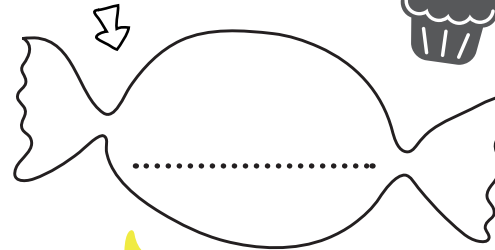

Large empty box for drawing or writing.

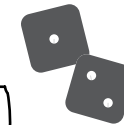

Das ist mein
Lieblingsspiel:



Wenn die Welt nur in
einer Farbe sein dürfte,
welche sollte das sein?

Das ist unter
meinem Bett:



Large empty box for drawing or writing.

Das esse ich
am liebsten:

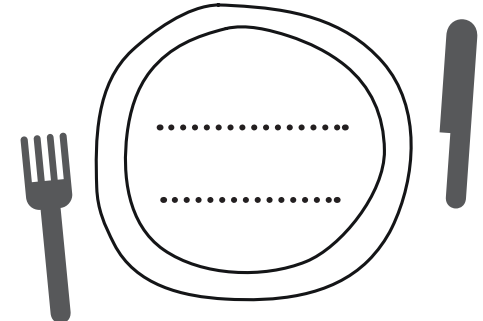

Das bin ich!
(Foto oder Zeichnung)



Mein Name:



Meine Adresse:



.....
.....



Dorthin würde ich gerne einmal reisen:



.....



Damit bringe
ich meine
Eltern auf die Palme:



.....
.....

Wenn ich eine Süßigkeit
wäre, wäre ich ...

.....



Wenn die Welt nur in
einer Farbe sein dürfte,
welche sollte das sein?



.....

Ruf doch mal an, wenn du
dich zum Spielen verabre-
den magst. Hier ist meine
Nummer!

Das finde ich gut!
(kreise ein!)



- Reisen
- Mathe
- Lesen
- Fußball
- Basteln
- Zeichnen
- Sommer
- Abenteuer
- Winter
- Eis
- Kino
- Schwimmen
- Musik

- Einkaufen
- Gemüse
- Regenwetter
- Hitze
- Dunkelheit
- Früh aufstehen
- Aufräumen
- Still sitzen
- Langeweile
- Mathe
- Spazieren

Das finde ich doof!



.....
.....



Das ist mein
Lieblingsspiel:

Das ist unter
meinem Bett:



.....
.....

Das esse ich
am liebsten:

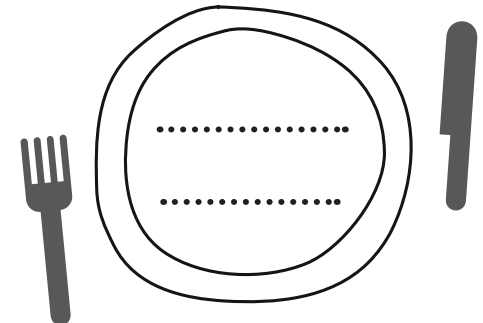

Zeichne oder schreibe etwas Nettes in einen Luftballon!



Das wünsche ich dir:

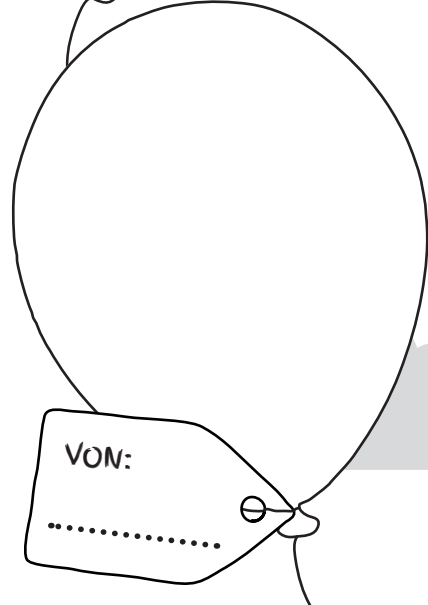
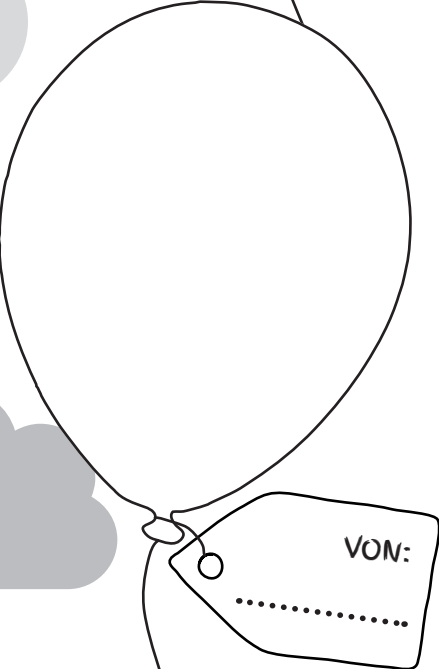
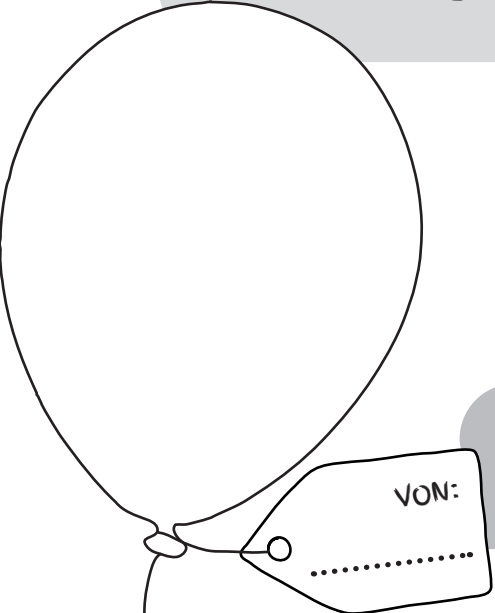
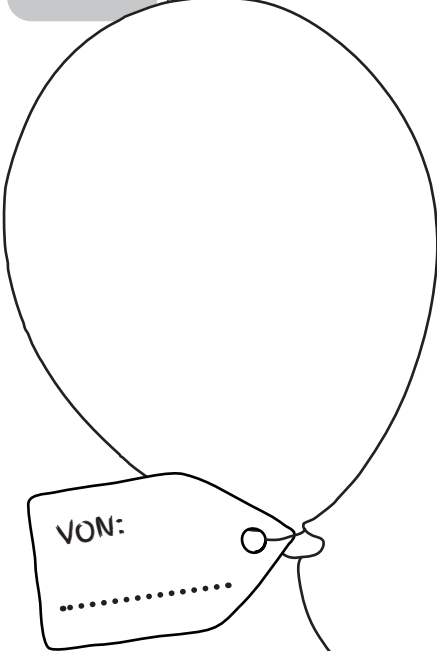
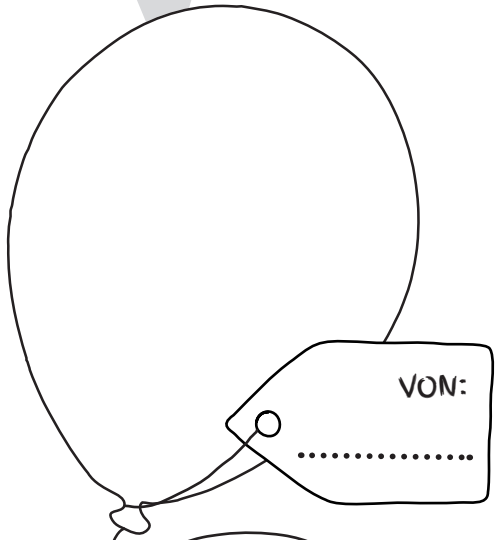
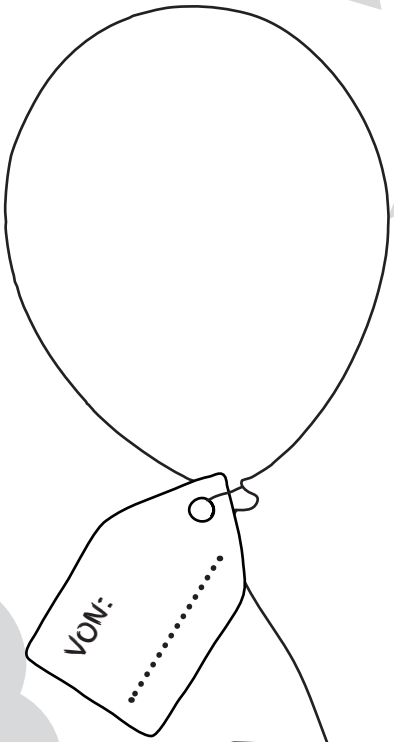
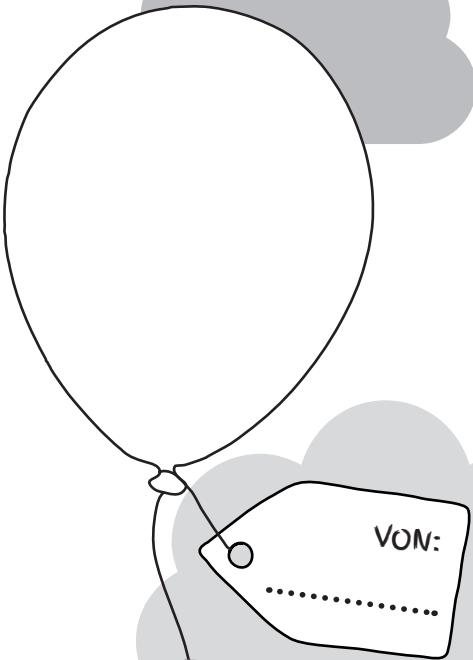
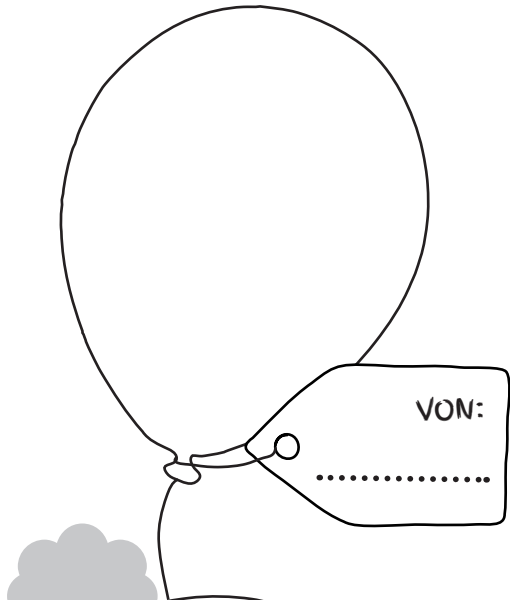

MEINE FREUNDE

Das ist mein Lieblingsinstrument:

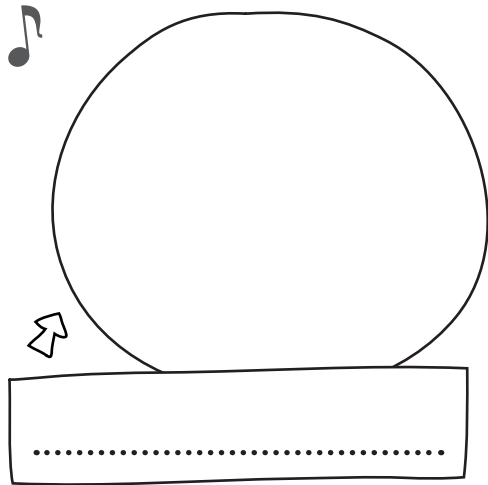

(Trage deinen Namen in das Rechteck ein und zeichne in den Kreis!)

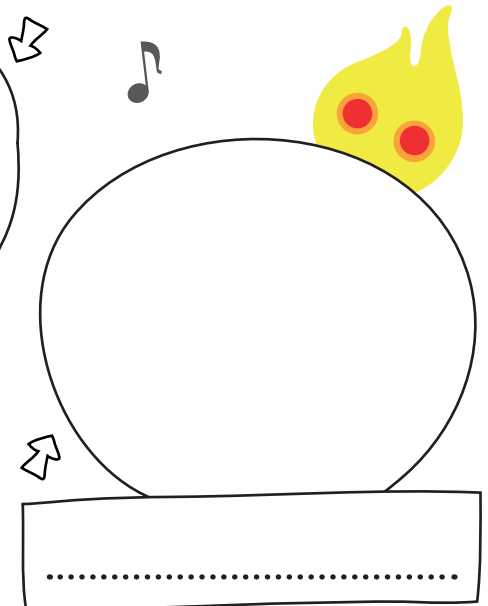
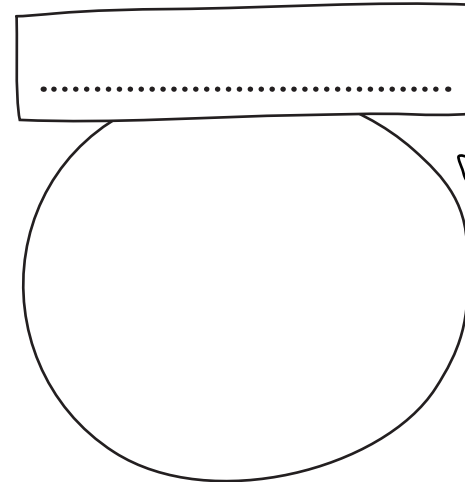
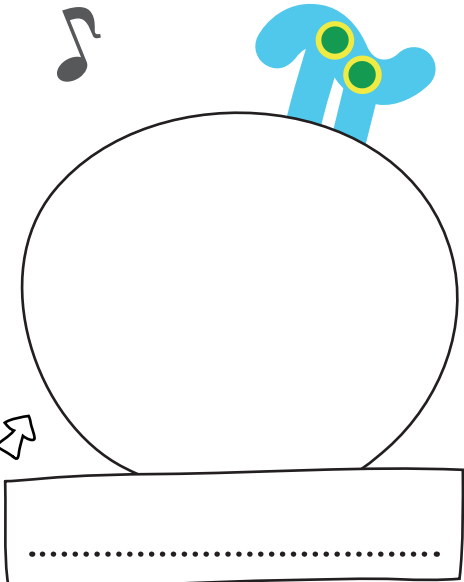
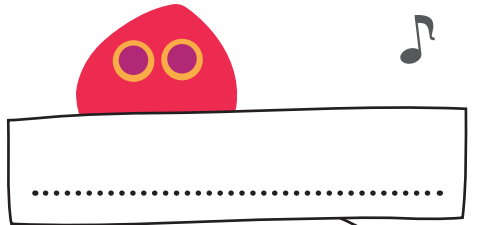
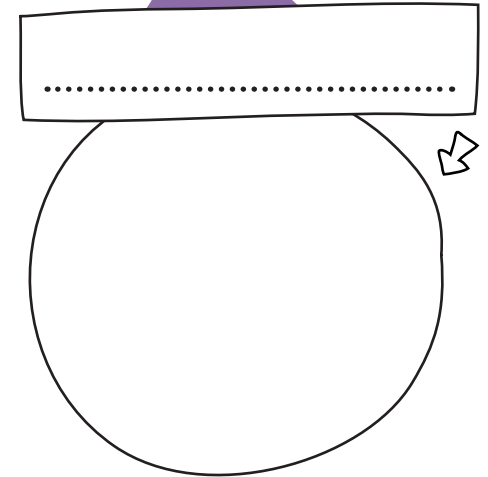
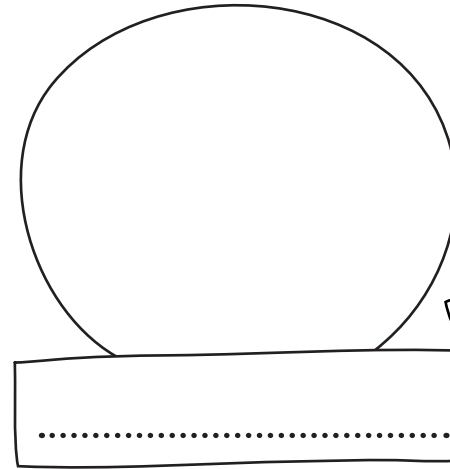
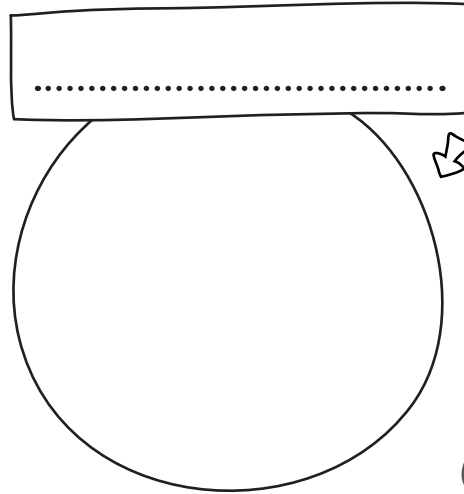

Das zaubert mir ein Lächeln auf die Lippen:

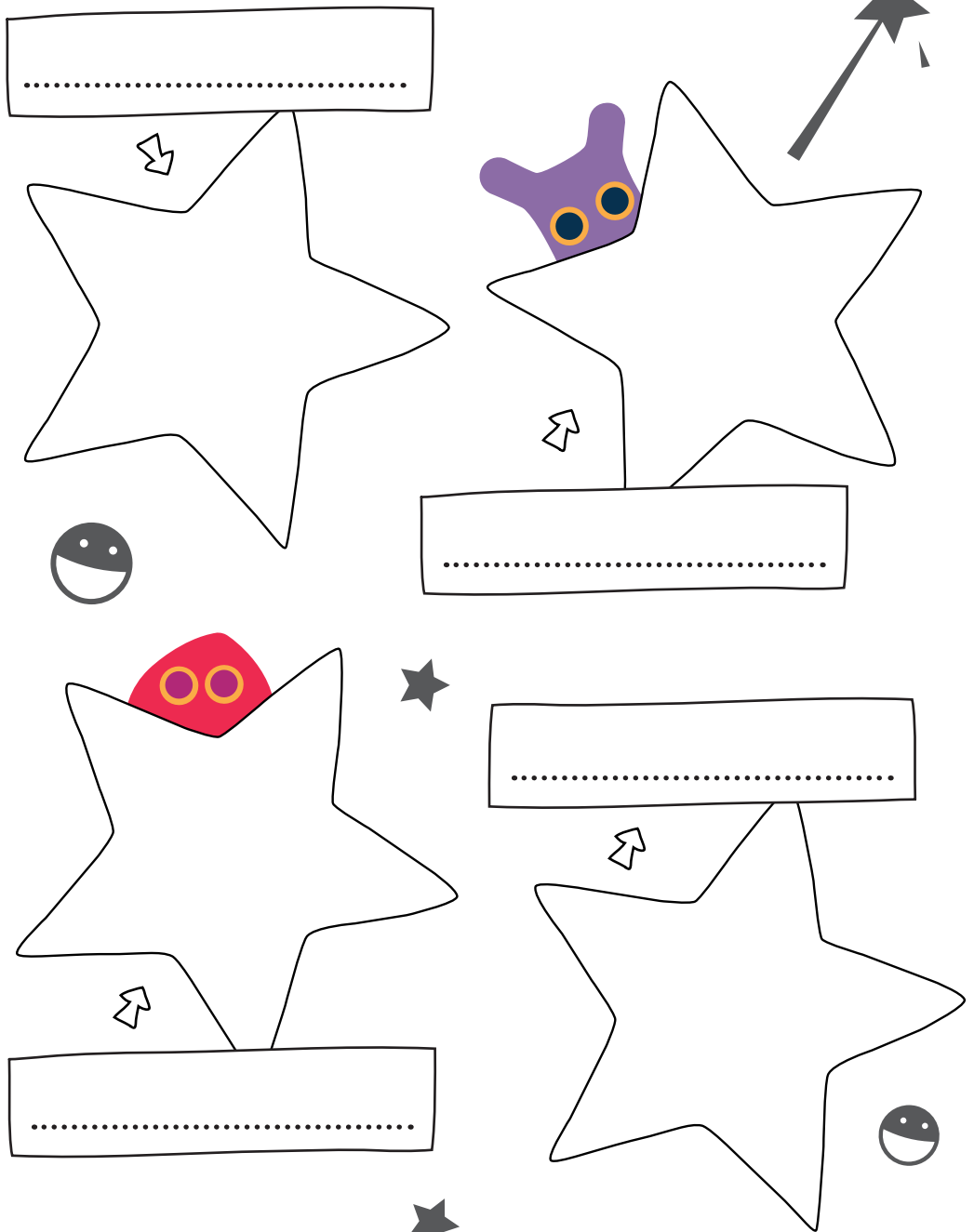

(Trage deinen Namen in das Rechteck ein und zeichne in den Stern!)

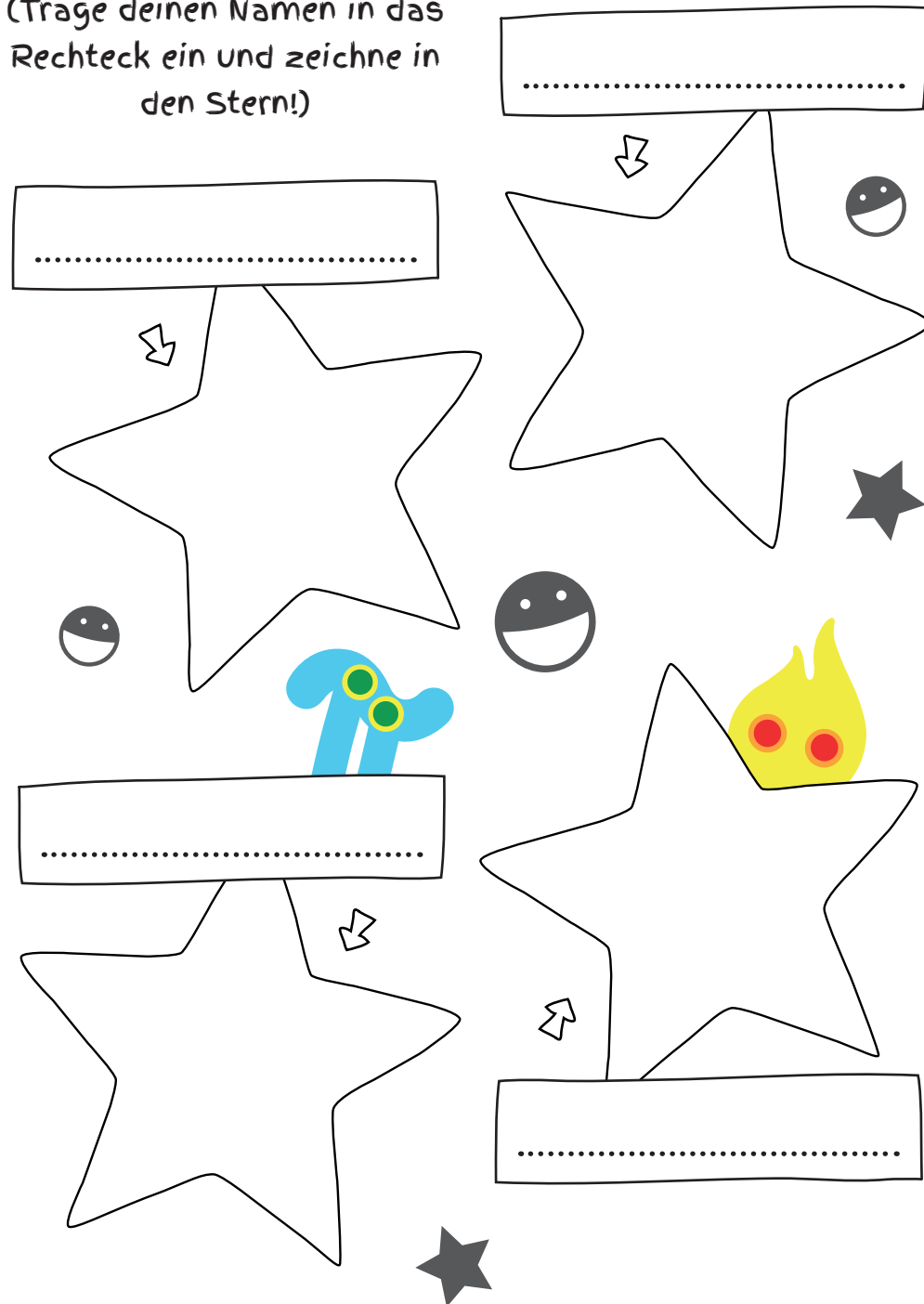

Mein Geburtstag ist am ...

Schreibe das Datum
in den Kreis und den
Monat und deinen Na-
men in das Rechteck.



.....

Monat:
.....

Name:
.....



Monat:
.....

Name:
.....

.....



Monat:
.....

Name:
.....

.....

.....

Monat:
.....

Name:
.....



Monat:
.....

Name:
.....

.....



.....

Monat:
.....

Name:
.....



Monat:
.....

Name:
.....

.....

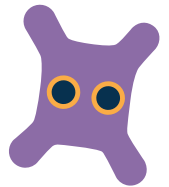

Schreiben oder zeichnen Sie etwas Nettes für Ihre/n Schüler/in in ein Kästchen!



Das bin ich!
(Foto oder Zeichnung)



Name:

.....

Fächer:

.....



Das bin ich!
(Foto oder Zeichnung)



Name:

.....

Fächer:

.....